



VBV-770DM vehicle CCTV monitor

Quick installation guide

Guide d'installation rapide

Quick installation guide

Guida di installazione rapida

Guía rápida de instalación

Snelle installatie handleiding



Stock code #3353A



1 Contents/Contenu/Inhalt/Contenuti/Contenidos/inhoud

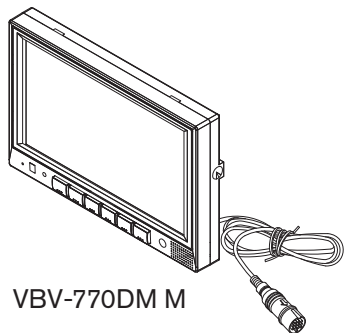

VBV-770DM M

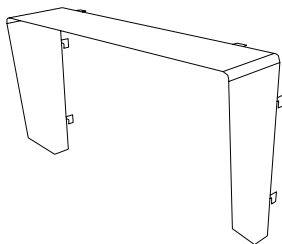

VBV-770DM SS

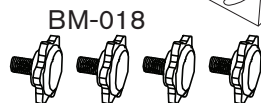
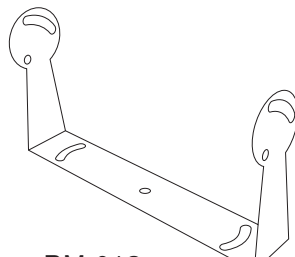

BM-018

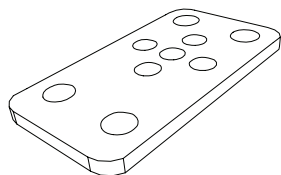

VBV-7X0DM RC

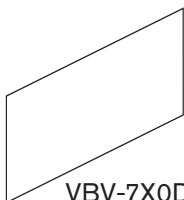

VBV-7X0DM RT

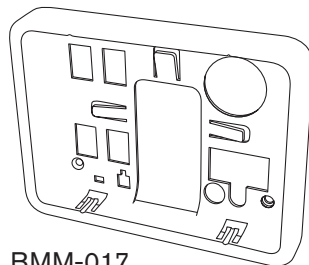

BMM-017

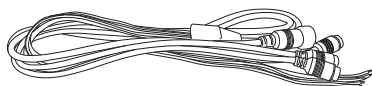

VBV-7X0DM CA

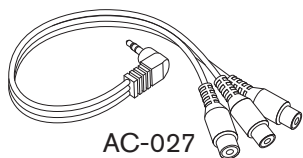

AC-027

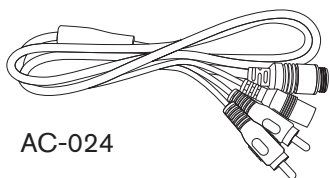

AC-024

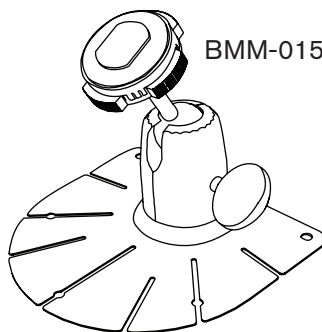

BMM-015

2 Monitor installation/Surveiller l'installation/ Monitor-Installation/L'installazione del monitor/ Vigilar la instalación/Monitor installatie

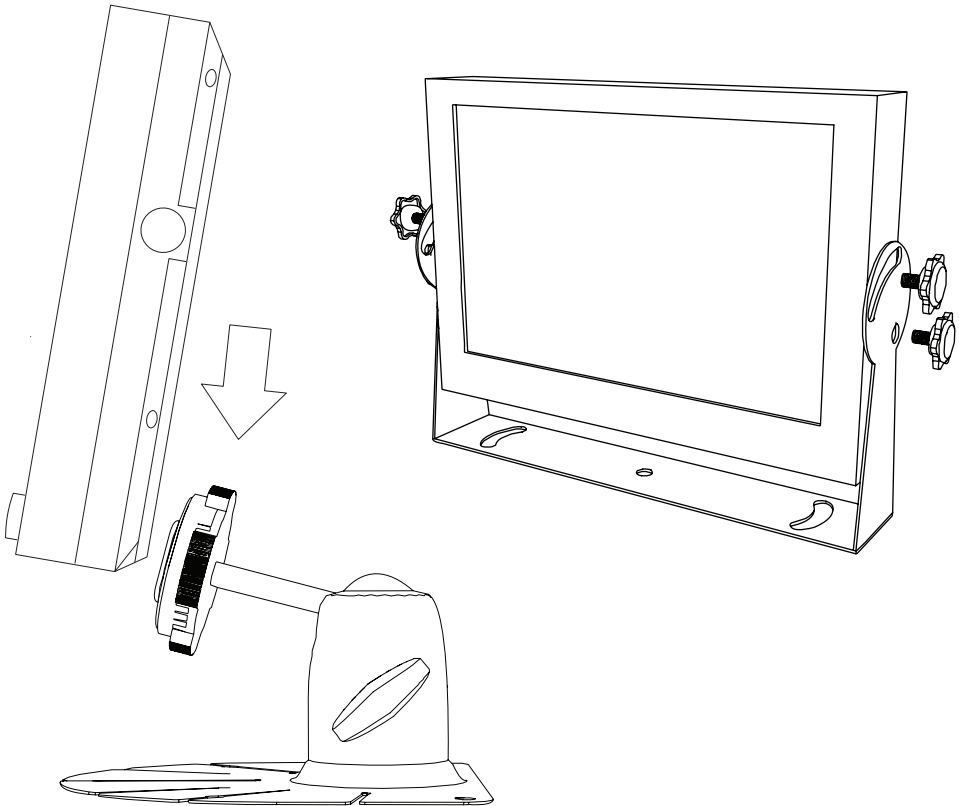
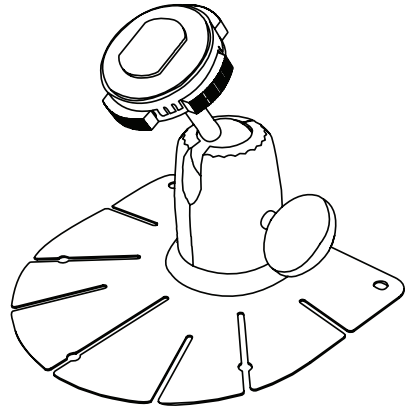
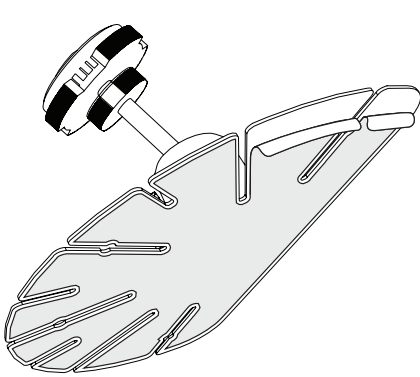

3 Connections/Connexions/Verbindungen/ Connessioni/Conexiones/Aansluitingen

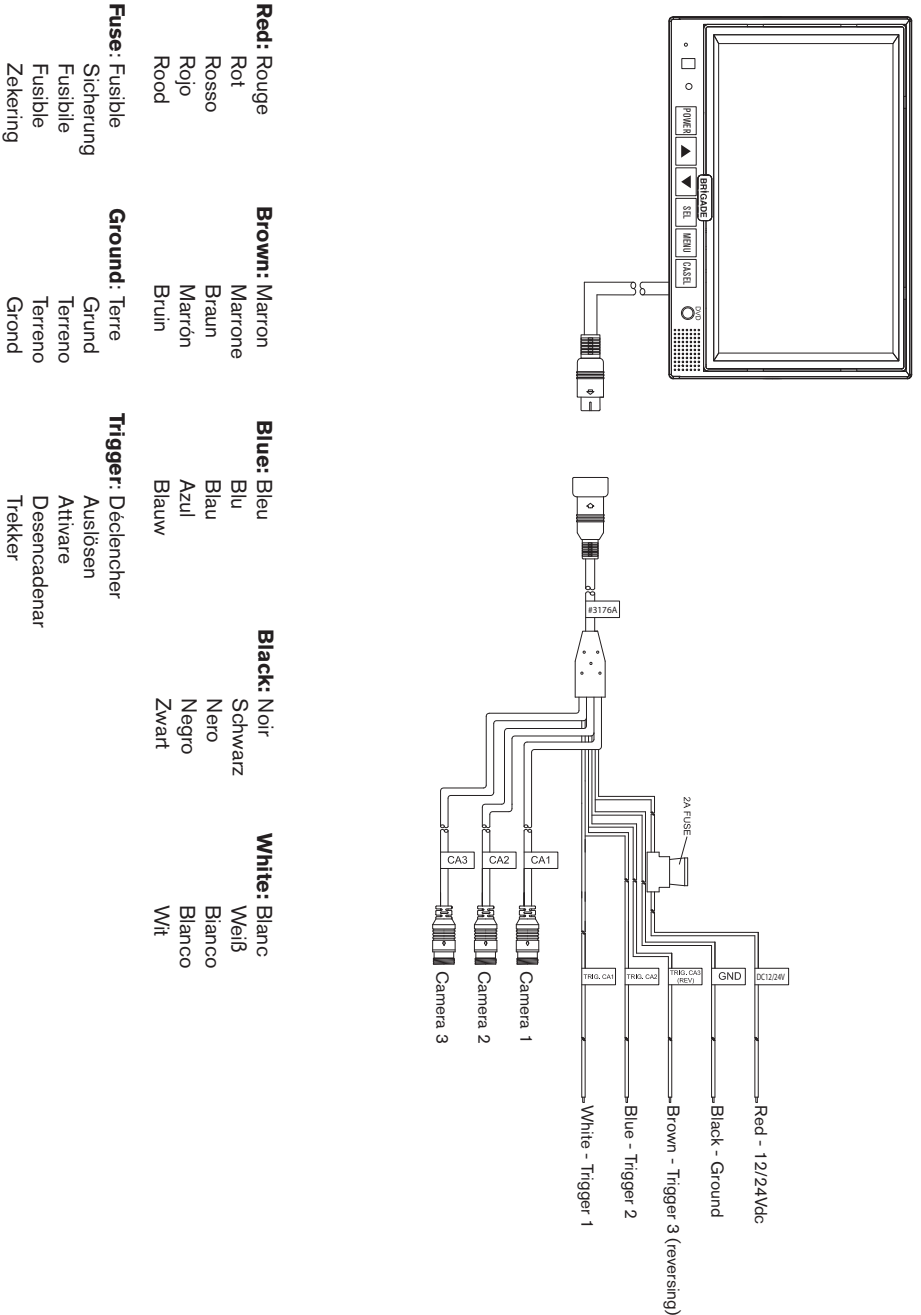

4 Controls/Contrôles/Kontrollen/Controlli/Controles/ Controles/

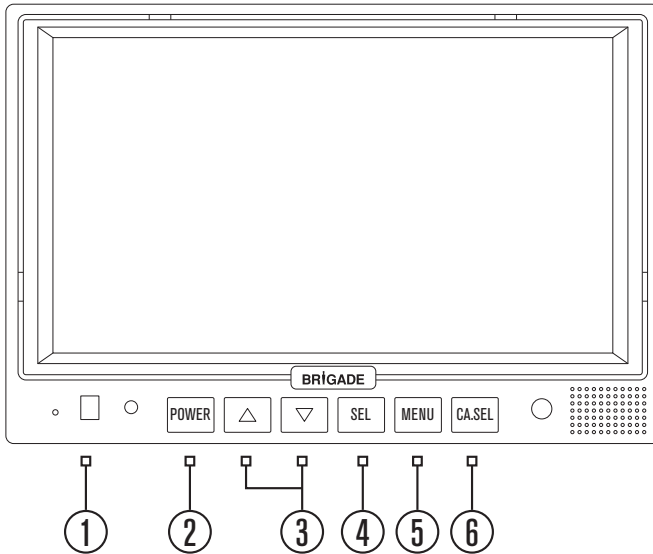

- ① Automatic low light sensor.
Capteur optique automatique de basse luminosité.
Automatischer Low-Light Sensor.
Sensore automatico di bassa luminosità.
Sensor automático de baja luminosidad.
Automatische low-light sensor.

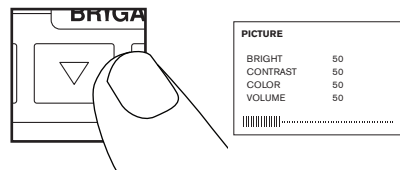
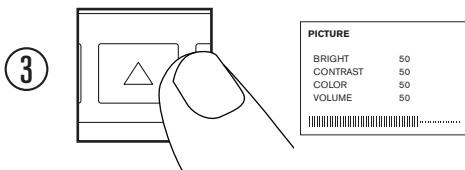
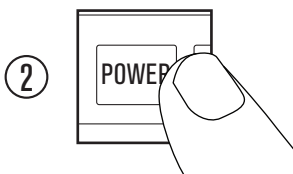

4 Controls/Contrôles/Kontrollen/Controlli/Controles/Controles

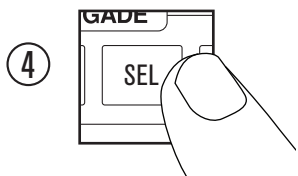

PICTURE	
BRIGHT	50
CONTRAST	50
COLOR	50
VOLUME	50

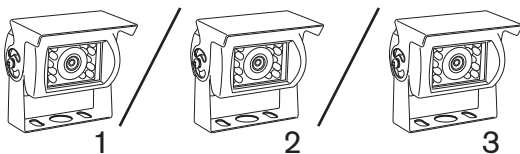
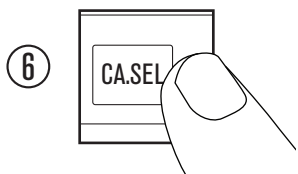
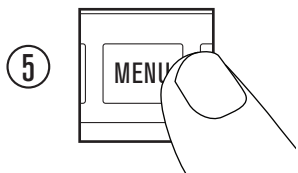
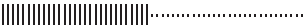

5 Operation/Opération/Betrieb/Operazione/Operación/ Werking

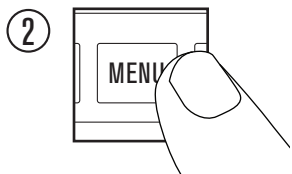
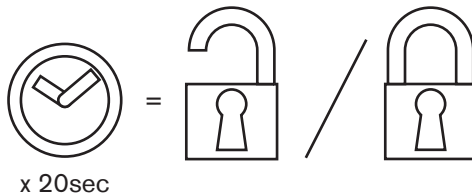
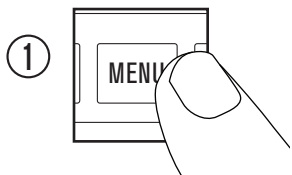

x 2 =

OPTION	
LANG	ENGLISH
SCALE	OFF
CAM 1	NORMAL
CAM 2	NORMAL
CAM 3	NORMAL

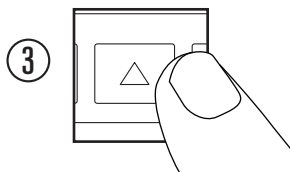

OPTION	
SPRACHE	DEUTSCH
SCALE	OFF
CAM 1	NORMAL
CAM 2	NORMAL
CAM 3	NORMAL

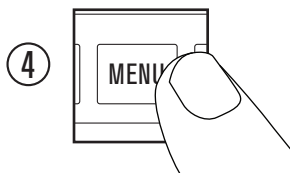

x 1 =

PICTURE	
BRIGHT	50
CONTRAST	50
COLOR	50
VOLUME	50

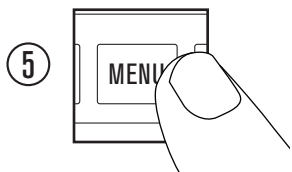

x 3 =

SYSTEM	
COLOR-SYS	PAL
BLUE BACK	OFF
HORIZONTAL	≡
VERTICAL	⇕
ZOOM	16:9

6 Set camera to mirror view

1

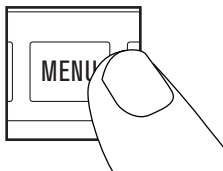

x 2 =

OPTION	
LANG	ENGLISH
SCALE	OFF
CAM 1	NORMAL
CAM 2	NORMAL
CAM 3	NORMAL

2

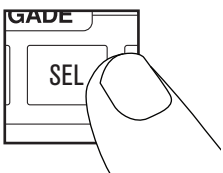

x 2 =

OPTION	
LANG	ENGLISH
SCALE	OFF
CAM 1	NORMAL
CAM 2	NORMAL
CAM 3	NORMAL

3

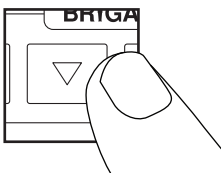

x 1 =

OPTION	
LANG	ENGLISH
SCALE	OFF
CAM 1	MIRROR
CAM 2	NORMAL
CAM 3	NORMAL



7 Specifications/Spécifications/ Spezifikationen/ Specifiche/Especificaciones/Specificaties

ENGLISH	
Specifications	
Monitor	VBV-770DM
TV system	NTSC/PAL
Picture	7" Digital TFT LCD colour monitor with on-screen display function
Display size	7" diagonal
Field of view	Top: 50°, Bottom: 60°, Left: 70°, Right: 70°
Resolution	(800x3(RGB)x480)
Picture image	Factory set to reverse image
Power	12/24Vdc input
Inputs	3 x camera, 1A/V
Dimensions	182(w) x 122(h) x 29.6(d)mm 7.17(w) x 4.8(h) x 1.17(d) inches
Operating temperature	-20°C ~ +70°C -40°F ~ +158°F

FRANCAIS	
Specifications	
Moniteur	VBV-770DM
Système TV	NTSC/PAL
Image	7" Numérique TFT LCD moniteur couleur avec affichage de fonction (OSD)
Dimension de l'écran	7" diagonale
Champ de vision	Haut: 50°, Bas: 60°, Gauche: 70°, Droite: 70°
Résolution	(800x3(RGB)x480)
Image vidéo	Réglage d'usine sur image inverse
Alimentation	12/24Vdc input
Entrées	3 x caméra, 1A/V
Dimensions	182(w) x 122(h) x 29,6(d)mm 7,17(w) x 4,8(h) x 1,17(d) inches
Température d'utilisation	-20°C ~ +70°C -40°F ~ +158°F

ITALIANO	
Specifiche	
Schermo	VBV-770DM
Sistema TV	NTSC/PAL
Immagine	7" digital TFT LCD colorare il monitor con la funzione di mostra sullo schermo
Formato display	7" diagonale
Campo visivo	Top: 50°, Bottom: 60°, Left: 70°, Right: 70°
Risoluzione	(800x3(RGB)x480)
Immagine a video	Immagine reversibile program- mabile
Alimentazione	12/24Vdc input
Prese	3 x telecamera, 1A/V
Dimensioni	182(w) x 122(h) x 29.6(d)mm 7.17(w) x 4.8(h) x 1.17(d) inches
Temperatura di servizio	-20°C ~ +70°C -40°F ~ +158°F

DEUTSCH	
Spezifikationen	
Monitor	VBV-770DM
TV-System	NTSC/PAL
Bild	7" digitalen TFT LCD Farbmonitor mit Funktionsanzeige (OSD)
Bildschirmgröße	7" diagonal
Sichtfeld	Oben: 50°, Unten: 60°, Links: 70°, Rechts: 70°
Auflösung	(800x3(RGB)x480)
Videobild	Werkseinstellung Reversebild
Stromversorgung	12/24Vdc input
Eingänge	3 x kamera, 1A/V
Abmessungen	182(w) x 122(h) x 29.6(d)mm 7.17(w) x 4.8(h) x 1.17(d) inches
Betriebstemperatur	-20°C ~ +70°C -40°F ~ +158°F

7 Specifications/Spécifications/Spesifikationen/ Specifiche/Especificaciones/Specificaties

ESPAÑOL	
Especificaciones	
Monitor	VBV-770DM
Sistema de TV	NTSC/PAL
Imagen	Monitor a color de 7" digital TFT LCD con visualización de las funciones (OSD)
Tamaño de pantalla	7" diagonal
Campo visual	arriba: 50°, abajo: 60°, a la izquierda: 70°, a la derecha: 70°
Resolución	(800x3(RGB)x480)
Imagen de video	Ajuste de fábrica de la imagen inversa
Suministro de corriente	12/24Vdc entrada
Entradas	3 x cámara, 1 A/V
Dimensiones	182(w) x 122(h) x 29.6(d)mm 7.17(w) x 4.8(h) x 1.17(d) inches
Temperatura de servicio	-20°C ~ +70°C -40°F ~ +158°F

NEDERLANDS	
Specificaties	
Monitor	VBV-770DM
TV-systeem	NTSC/PAL
Beeld	7" digitale TFT LCD kleurenmonitor met on-screen display functie
Displayformaat	7" diagonaal
Gezichtsveld	Boven: 50°, Onder: 60°, Links: 70°, Rechts: 70°
Resolutie	(800x3(RGB)x480)
Videobeeld	Fabrieksinstelling reversebeeld
Stroomvoorziening	12/24Vdc Ingang
Ingangen	3 x camera, 1 A/V
Afmetingen	182(w) x 122(h) x 29.6(d)mm 7.17(w) x 4.8(h) x 1.17(d) inches
Bedrijfstemperatuur	-20°C ~ +70°C -40°F ~ +158°F

Specifications subject to change. Sous réserve de modifications techniques. Vorbehaltlich technischer Änderungen. Con riserva di modifichite tecniche. Reservadas las modificaciones técnicas. Technische wijzigingen voorbehouden.

Disclaimer

Camera monitor systems are an invaluable driver aid but do not exempt the driver from taking every normal precaution when conducting a manoeuvre. No liability arising out of the use or failure of the product can in any way be attached to Brigade or to the distributor.

Dénégation

Les systèmes de moniteurs des caméras sont une aide précieuse pour le conducteur, mais celui-ci doit toutefois prendre toutes les précautions nécessaires pendant les manœuvres. Brigade ou ses distributeurs n'assument aucune responsabilité résultant de l'utilisation ou d'un défaut du produit.

Verzichterklärung

Die Kamerabildschirmssysteme sind eine wertvolle Hilfe für den Fahrer, entbinden ihn jedoch nicht von der notwendigen Sorgfalt beim Manövrieren des Fahrzeuges. Brigade und seine Vertriebshändler haften nicht für Schäden aus der Nutzung oder einer Fehlfunktion des Produktes.

Disconoscimento

I sistemi di monitor della telecamera sono un aiuto prezioso per il conduttore, ma non lo esonerano dall'obbligo di prendere le precauzioni necessarie durante le manovre del veicolo. Brigade e i suoi distributori non si assumono nessuna responsabilità per danni risultanti dall'utilizzo o da un malfunzionamento del prodotto.

Negante

Los sistemas de pantalla de cámara son una valiosa ayuda destinada a los conductores; en todo caso no les resta la responsabilidad de proceder con precaución a la hora de maniobrar con el vehículo. Brigade y sus distribuidores comerciales no se responsabilizan de los daños derivados de un mal funcionamiento del producto.

Verwerping

De camera-monitorsystemen zijn een waardevolle hulp voor de bestuurder, ontheffen hem echter niet van de nodige zorgvuldigheid bij het manoeuvreren van het voertuig. Brigade en zijn distributeurs zijn niet aansprakelijk voor schade door gebruik of een gebrek van het product.

Serial No:

Stock code:

Head Office

Brigade Electronics Plc
Brigade House, The Mills
Station Road, South Darent
DA4 9BD United Kingdom
Tel: +44 (0)1322 420300
Fax: +44 (0)1322 420343
email: sales@brigade-electronics.com

Brigade Electronics Inc

202 Delaware Avenue, Suite 1
Palmerton PA 18071 USA
Tel: +1 (610) 826-7870
Fax: +1 (484) 229-0088
email: infousa@brigade-electronics.com

Brigade Electronique Sarl

22 Rue Pierre Bontemps
72000 Le Mans
France
Tel: +33 (0) 2 23 61 08 97
Fax +33 (0) 2 23 61 08 97
email: info@brigade-electronique.fr

Brigade Elettronica srl

Via V. Alfieri, 28
50121 Firenze
Italia
Telefono: +39 (0) 55-245943
Fax: +44 (0) 1322 420343 (servizio clienti)
email: info-italia@brigade-electronics.com

Brigade Elektronik GmbH

Haberstr. 36 A
24537 Neumünster Germany
Telefon: +49 (0) 4321 555 362
Fax: +49 (0) 4321 555 361
email: info@brigadegmbh.de

Brigade Electronika (PTY) Ltd

P.O. Box 53203
Wierdapark 0149
South Africa
Tel: +27 (0) 72 757 7166
Fax: +27 (0) 866 963 238
email: brigade@ballmail.co.za

Brigade Electronics BV

Gesseltweg 4
6089 NT Heibloem
The Netherlands
Tel: +31 475 44 06 23
Fax: +31 475 49 54 76
email: info@brigade-electronics.nl

